

Compact Cylinder

Double Acting, Single Rod ; Single Acting, Spring Return / Extend

Series SDA, SSA, STA

◆ How to Order

SDA S 20 - 30 - B

Rod end thread

Nil	Female thread	B	Male thread	N	No thread
-----	---------------	---	-------------	---	-----------

* The length of no thread's rod is the same as the rod as with female thread.

Cylinder stroke

* Refer to "Standard stroke" .

Bore size (mm)

SDA Series									
12	16	20	25	32	40	50	63	80	100
SSA, STA Series									
12	16	20	25	32	40				

Magnet

Nil	Without magnet	S	Built-in magnet
-----	----------------	---	-----------------

Model

SDA	Double-acting	SSA	Single acting, spring return
STA	Single acting, spring extend		



Symbol

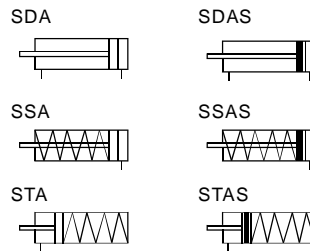

◆ Specifications

Bore size (mm)		12	16	20	25	32	40	50	63	80	100
Action	SDA	Double acting, single rod / double rod									
	SSA / STA	Single acting, spring return / extend								-	
Fluid		Filtered compressed air									
Proof pressure		1.5 MPa									
Operating pressure range	SDA	0.1~0.9 MPa									
	SSA / STA	0.2~0.9 MPa								-	
Ambient and fluid temperature		-10~70°C (No freezing)									
Port size		M5×0.8			Rc1/8			Rc1/4	Rc3/8		
Piston rod thread	Female thread	M3×0.5	M4×0.7	M5×0.8	M6×1.0	M8×1.25	M10×1.5	M14×1.5	M18×1.5	M18×1.5	M26×1.5
	Male thread	M5×0.8	M6×1.0	M8×1.25	M10×1.25	M14×1.5	M18×1.5	M22×1.5	M26×1.5	M26×1.5	
Cushion		Rubber bumper									

Note): Please contact with ANSSION for the mounting accessories.

Bore size (mm)	Standard stroke (mm)	
	Double acting, single / double rod	Single acting, spring return / extend
12, 16	5~60	5~30 Only for φ 12,16,20,25,32,40
20	5~85	
25	5~110	
32 to 100	5~130	

* When stroke exceeds the standard range, Please contact with ANSSION.

Compact Cylinder

Double Acting, Single Rod ; Single Acting, Spring Return / Extend

Series SDA, SSA, STA



◆ Dimensions

SDA(S) □-□ Φ 12,16
(Basic style)

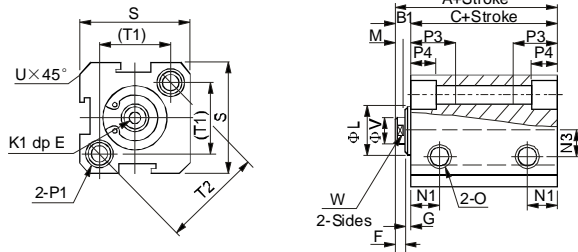

SDA(S) □-□ Φ 20 to 100
(Basic style)

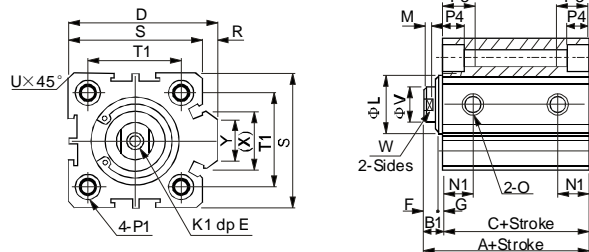

Bore size(mm)	Without magnet			Built-in magnet			D	E		F	G	K1	L	M	N1	N3
	A	B1	C	A	B1	C		ST≤10	ST>10							
12	22	5	17	32	5	27	-	6	4	1	M3×0.5	10.2	2.8	6.3	6	
16	24	5.5	18.5	34	5.5	28.5	-	6	4	1.5	M3×0.5	11	2.8	7.3	6.5	
20	25	5.5	19.5	35	5.5	29.5	36	8	4	1.5	M4×0.7	15	2.8	7.5	-	
25	27	6	21	37	6	31	42	10	4	2	M5×0.8	17	2.8	8	-	
32	31.5	7	24.5	41.5	7	34.5	50	12	4	3	M6×1.0	22	2.8	9	-	
40	33	7	26	43	7	36	58.5	12	4	3	M8×1.25	28	2.8	10	-	
50	37	9	28	47	9	38	71.5	15	5	4	M10×1.5	38	2.8	10.5	-	
63	41	9	32	51	9	42	84.5	15	5	4	M10×1.5	40	2.8	11.8	-	
80	52	11	41	62	11	51	104	15	6	5	M14×1.5	45	4	14.5	-	
100	63	12	51	73	12	61	124	18	7	5	M18×1.5	55	4	20.5	-	

Bore size(mm)	O	P1	P3	P4	R	S	T1	T2	U	V	W	X	Y
16	M5×0.8	Both sides: Φ6.5 Thread: M5×0.8 Thru.hole: Φ4.2	12	4.5	-	29	19.8	28	1.6	6	5	-	-
20	M5×0.8	Both sides: Φ6.5 Thread: M5×0.8 Thru.hole: Φ4.2	14	4.5	2	34	24	-	2.1	8	6	11.3	10
25	M5×0.8	Both sides: Φ8.2 Thread: M6×1.0 Thru.hole: Φ4.6	15	5.5	2	40	28	-	3.1	10	8	12	10
32	Rc1/8	Both sides: Φ8.2 Thread: M6×1.0 Thru.hole: Φ4.6	16	5.5	6	44	34	-	2.15	12	10	18.3	15
40	Rc1/8	Both sides: Φ10 Thread: M8×1.25 Thru.hole: Φ6.5	20	7.5	6.5	52	40	-	2.25	16	14	21.3	16
50	Rc1/4	Both sides: Φ11 Thread: M8×1.25 Thru.hole: Φ6.5	25	8.5	9.5	62	48	-	4.15	20	17	30	20
63	Rc1/4	Both sides: Φ11 Thread: M8×1.25 Thru.hole: Φ6.5	25	8.5	9.5	75	60	-	3.15	20	17	28.7	20
80	Rc3/8	Both sides: Φ14 Thread: M12×1.75 Thru.hole: Φ9.2	25	10.5	10	94	74	-	3.65	25	22	36	26
100	Rc3/8	Both sides: Φ17.5 Thread: M14×2 Thru.hole: Φ11.3	30	13	10	114	90	-	3.65	32	27	35	26

SSA(S) □-□ Φ 12,16
(Spring return style)

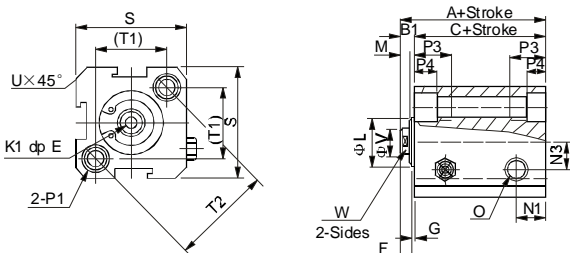

SSA(S) □-□ Φ 20 to 40
(Spring return style)

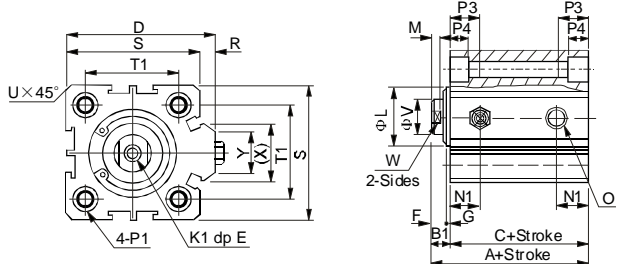

I

CJP

CJ1

DNC

DNCB

DNG

C95

SI

CS1

MB

SU

SC

DSNU

C85

CJ2

CM2

MA

MAL

ADVU

CQ2

CQS

SDA

CU

DPZ

CXS

TN

ADVUL

CQM

MGP

MGG

CRA1

CY1B

CS

Auto switch

D

Auto switch

AC,AD

HR

RB

RBQ

Compact Cylinder

Double Acting, Single Rod ; Single Acting, Spring Return / Extend

Series SDA, SSA, STA

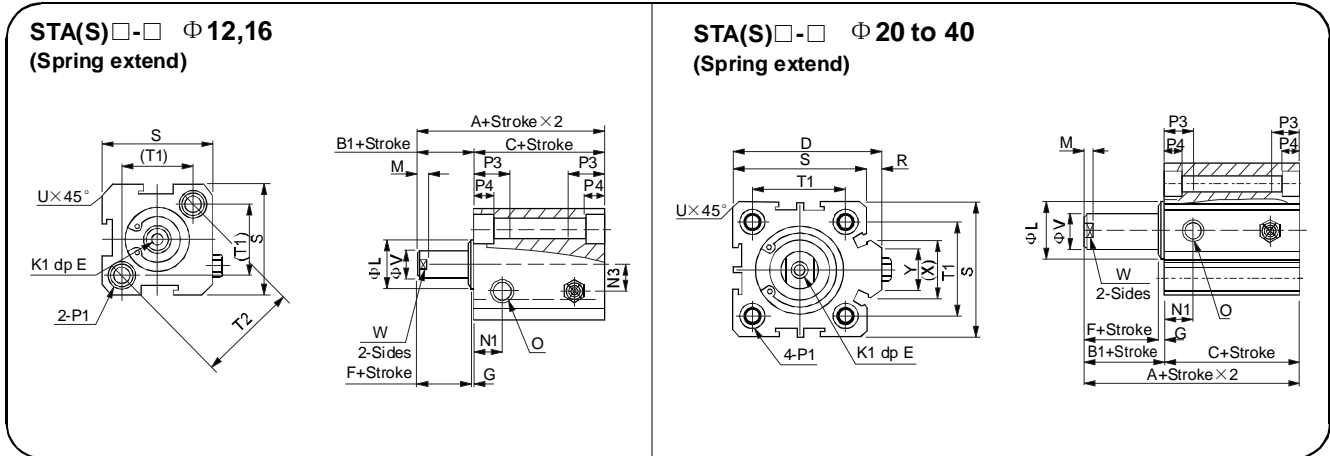

SSA(S) □-□ / STA(S) □-□

Bore size (mm)	Without magnet			Built-in magnet			D	E	F	G	K1	L	M	N1	N3				
	A	B1	C	A	B1	C													
Stroke	ST≤10	ST>10	B1	ST≤10	ST>10	ST≤10	ST>10	B1	ST≤10	ST>10									
12	32	42	5	27	37	42	52	5	37	47	-	6	4	1	M3×0.5	10.2	2.8	6.3	6
16	34	44	5.5	28.5	38.5	44	54	5.5	38.5	48.5	-	6	4	1.5	M3×0.5	11	2.8	7.3	6.5
20	35	45	5.5	29.5	39.5	45	55	5.5	39.5	49.5	36	8	4	1.5	M4×0.7	15	2.8	7.5	-
25	37	47	6	31	41	47	57	6	41	51	42	10	4	2	M5×0.8	17	2.8	8	-
32	41.5	51.5	7	34.5	44.5	51.5	61.5	7	44.5	54.5	50	12	4	3	M6×1.0	22	2.8	9	-
40	43	53	7	36	46	53	63	7	46	56	58.5	12	4	3	M8×1.25	28	2.8	10	-

Bore size	O	P1	P3	P4	R	S	T1	T2	U	V	W	X	Y
12	M5×0.8	Both sides: Φ 6.5 Thread: M5×0.8 Thru.hole: Φ 4.2	12	4.5	-	25	16.2	23	1.6	6	5	-	-
16	M5×0.8	Both sides: Φ 6.5 Thread: M5×0.8 Thru.hole: Φ 4.2	12	4.5	-	29	19.8	28	1.6	6	5	-	-
20	M5×0.8	Both sides: Φ 6.5 Thread: M5×0.8 Thru.hole: Φ 4.2	14	4.5	2	34	24	-	2.1	8	6	11.3	10
25	M5×0.8	Both sides: Φ 8.2 Thread: M6×1.0 Thru.hole: Φ 4.6	15	5.5	2	40	28	-	3.1	10	8	12	10
32	Rc1/8	Both sides: Φ 8.2 Thread: M6×1.0 Thru.hole: Φ 4.6	16	5.5	6	44	34	-	2.15	12	10	18.3	15
40	Rc1/8	Both sides: Φ 10 Thread: M8×1.25 Thru.hole: Φ 6.5	20	7.5	6.5	52	40	-	2.25	16	14	21.3	16

* Max.stroke up to 30mm, For longer stroke, Please contact with anssion.

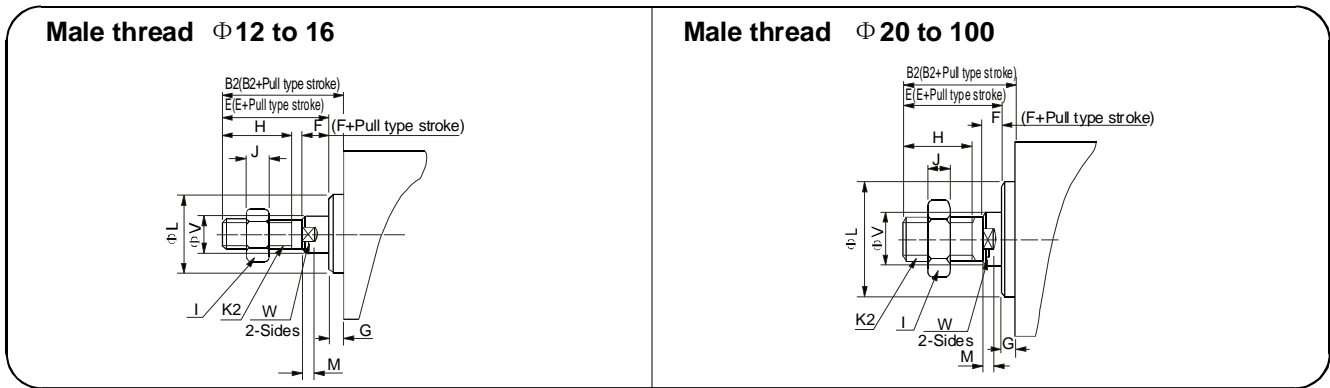

Bore size (mm)	B2	E	F	G	H	I	J	K2	L	M	V	W
12	17	16	4	1	10	8	4	M5×0.8	10.2	2.8	6	5
16	17.5	16	4	1.5	10	8	4	M5×0.8	11	2.8	6	5
20	20.5	19	4	1.5	13	10	5	M6×1.0	15	2.8	8	6
25	23	21	4	2	15	12	6	M8×1.25	17	2.8	10	8
32	25	22	4	3	15	17	6	M10×1.25	22	2.8	12	10
40	35	32	4	3	25	19	8	M14×1.5	28	2.8	16	14
50	37	33	5	4	25	27	11	M18×1.5	38	2.8	20	17
63	37	33	5	4	25	27	11	M18×1.5	40	2.8	20	17
80	44	39	6	5	30	32	13	M22×1.5	45	4	25	22
100	50	45	7	5	35	36	13	M26×1.8	55	4	32	27